

TYPE NUMBER 2
2.54mm PITCH, OPEN

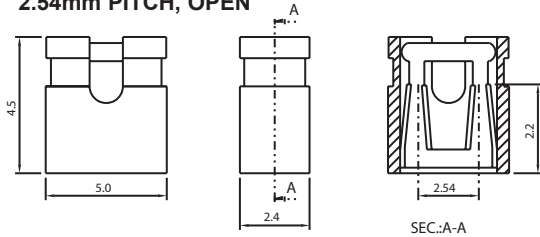

TYPE NUMBER 3
2.54mm PITCH, OPEN

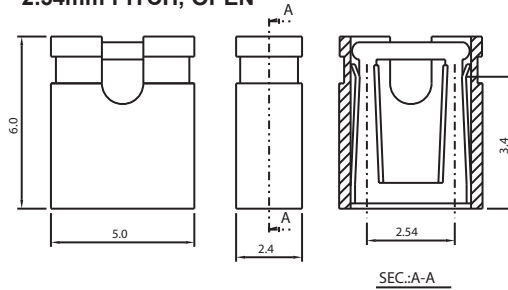

TYPE NUMBER 3
2.54mm PITCH, OPEN
MULTI SHUNT

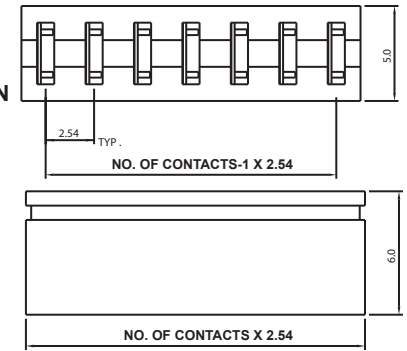
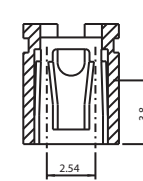

TYPE NUMBER 4
2.54mm PITCH, CLOSED

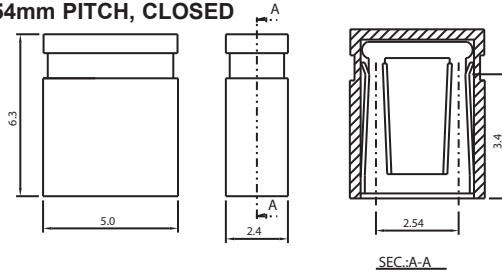

TYPE NUMBER 5
2.54mm PITCH, OPEN

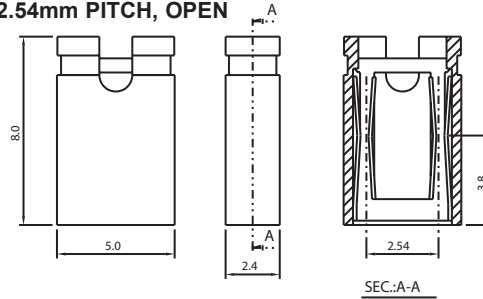

TYPE NUMBER 6
2.54mm PITCH, CLOSED

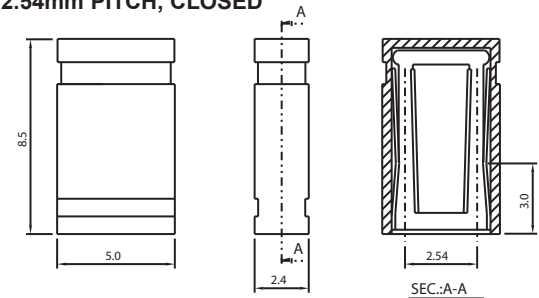

TYPE NUMBER 7
2.54mm PITCH, OPEN; EXTENDED HANDLE

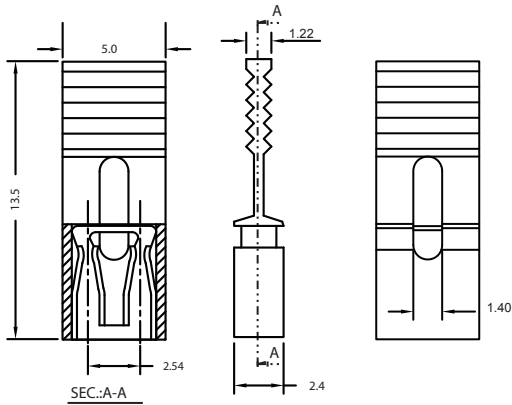

MATERIAL

Insulator - Thermoplastic with 30 % Glass Fill (PBT)
Contact - Phosphor Bronze
Plating - Au or Sn over Nickel

ELECTRICAL

Contact Resistance -20 milliohms Max.
Current Rating - 3 Amp
Dielectric Withstanding Voltage - 1000 VAC/Min
Operating Temperature -(-40C to 105C)
Insulation Resistance - 500 Mega Ohms Min

HOW TO ORDER:

B 0 7 1 - X X X 1 - 0 X X - Z

TYPE NUMBER
SEE TYPE NUMBER ABOVE

PITCH:
1 - 2.00mm

COLOR:
1 - BLACK
2 - RED
3 - YELLOW
4 - GREEN
5 - BLUE
6 - GRAY
7 - WHITE

CONTACT PLATING:
0 - TIN PLATED
1 - 1u" GOLD
2 - 3u" GOLD
3 - 10u" GOLD
4 - 15u" GOLD
5 - 30u" GOLD

Z= RoHS COMPLIANT

FOR MULTI SHUNT ONLY
NUMBER OF POSITIONS:

00 - N/A
02 thru 10

| Rev | Drawn | Checked | Apprvd. | Date |
|-----|-------|---------|---------|----------|
| 0 | A.M. | S.M. | S.M. | 10/16/03 |
| A | G.T. | S.M. | S.M. | 10/27/05 |
| B | B.S. | S.M. | S.M. | 04/07/15 |

SMP TECHNOLOGY, INC.

Shunts, 2.00mm Pitch ; RoHS Complinat

TOL. DEC. .X +/- 0.35 .XX +/- 0.25 .XXX +/- 0.15 ANGLE +/- UNIT: mm

SERIES: B071-xxx1-0xx-z