

TYPE NUMBER 2
2.54mm PITCH, OPEN

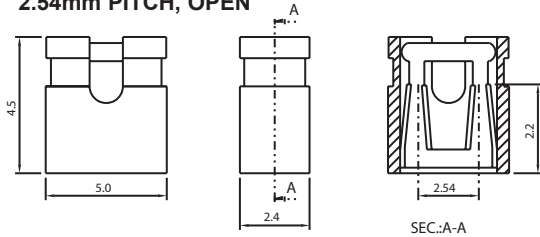

TYPE NUMBER 3
2.54mm PITCH, OPEN

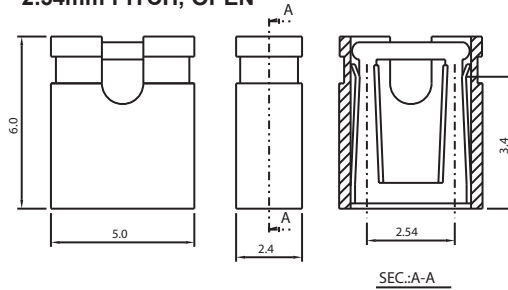

TYPE NUMBER 3
2.54mm PITCH, OPEN
MULTI SHUNT

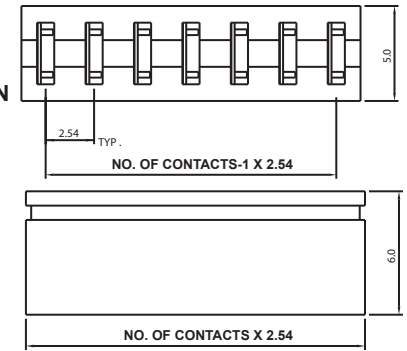
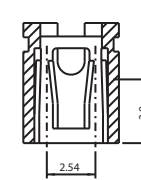

TYPE NUMBER 4
2.54mm PITCH, CLOSED

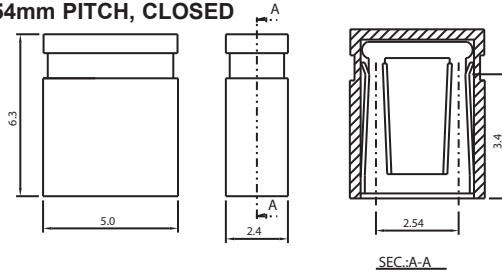

TYPE NUMBER 5
2.54mm PITCH, OPEN

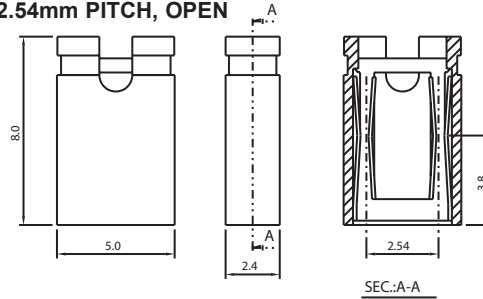

TYPE NUMBER 6
2.54mm PITCH, CLOSED

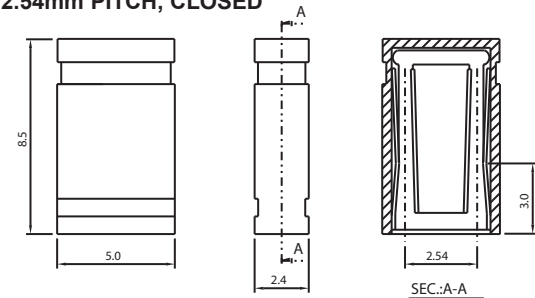

TYPE NUMBER 7
2.54mm PITCH, OPEN; EXTENDED HANDLE

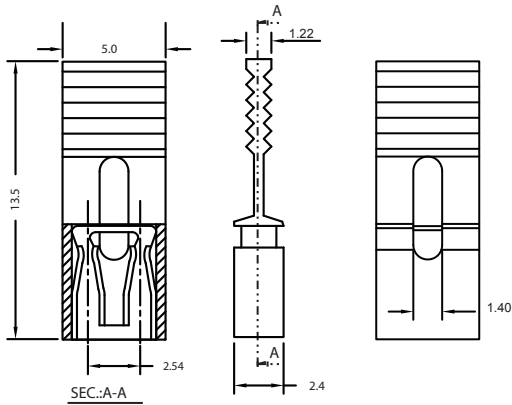

MATERIAL

Insulator - Thermoplastic with 30 % Glass Fill (PBT)
Contact - Phosphor Bronze
Plating - Au or Sn over Nickel

ELECTRICAL

Contact Resistance -20 milliohms Max.
Current Rating - 3 Amp
Dielectric Withstanding Voltage - 1000 VAC/Min
Operating Temperature -(-40C to 105C)
Insulation Resistance - 500 Mega Ohms Min

HOW TO ORDER:

B 0 7 1 - **X** **X** **X** **0** - **0** **X** **X** - **Z**

TYPE NUMBER **PITCH:** **COLOR:** **CONTACT PLATING:**

SEE TYPE NUMBER ABOVE 0 - 2.54mm 1 - BLACK 0 - TIN PLATED

FOR MULTI SHUNT ONLY
NUMBER OF POSITIONS:

00 - N/A
02 thru 10

- 2 - RED
 - 3 - YELLOW
 - 4 - GREEN
 - 5 - BLUE
 - 6 - GRAY
 - 7 - WHITE
- 1 - 1u" GOLD
 - 2 - 3u" GOLD
 - 3 - 10u" GOLD
 - 4 - 15u" GOLD
 - 5 - 30u" GOLD

Z= RoHS COMPLIANT

| Rev | Drawn | Checked | Apprvd. | Date |
|-----|-------|---------|---------|----------|
| 0 | A.M. | S.M. | S.M. | 10/16/03 |
| A | G.T. | S.M. | S.M. | 10/27/05 |
| B | B.S. | S.M. | S.M. | 04/07/15 |

SMP TECHNOLOGY, INC.

Shunts, 2.54mm Pitch ; RoHS Complinat

TOL. DEC. .X +/- 0.35 .XX +/- 0.25 .XXX +/- 0.15 ANGLE +/- UNIT: mm

SERIES: B071-xxx0-0xx-z